

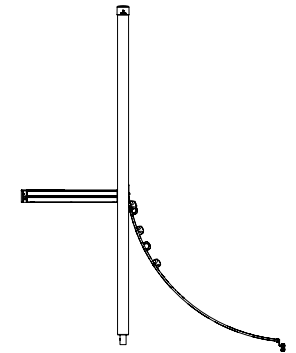





**OM**



BOM ID	IMAGE	QUANTITY	DESCRIPTION	DOCUMENT ID	WEIGHT
1		1	Wobble Climb, OM	SW70048	40.46
2		1	Protection pipe	SW33924	2.55
3		2	Handle	SW38012	0.79
4		16	Screw, thr-forming M6x25-8.8-(I-SO7380)	8027762	0.007
11		8	Screw, thr-forming M8x25-8.8-(I-SO7380)	8008506	0.013
12		4	Expansion anchor M8x71 HDG	8008557	0.08

BOM ID	IMAGE	QUANTITY	DESCRIPTION	DOCUMENT ID	WEIGHT
--------	-------	----------	-------------	-------------	--------

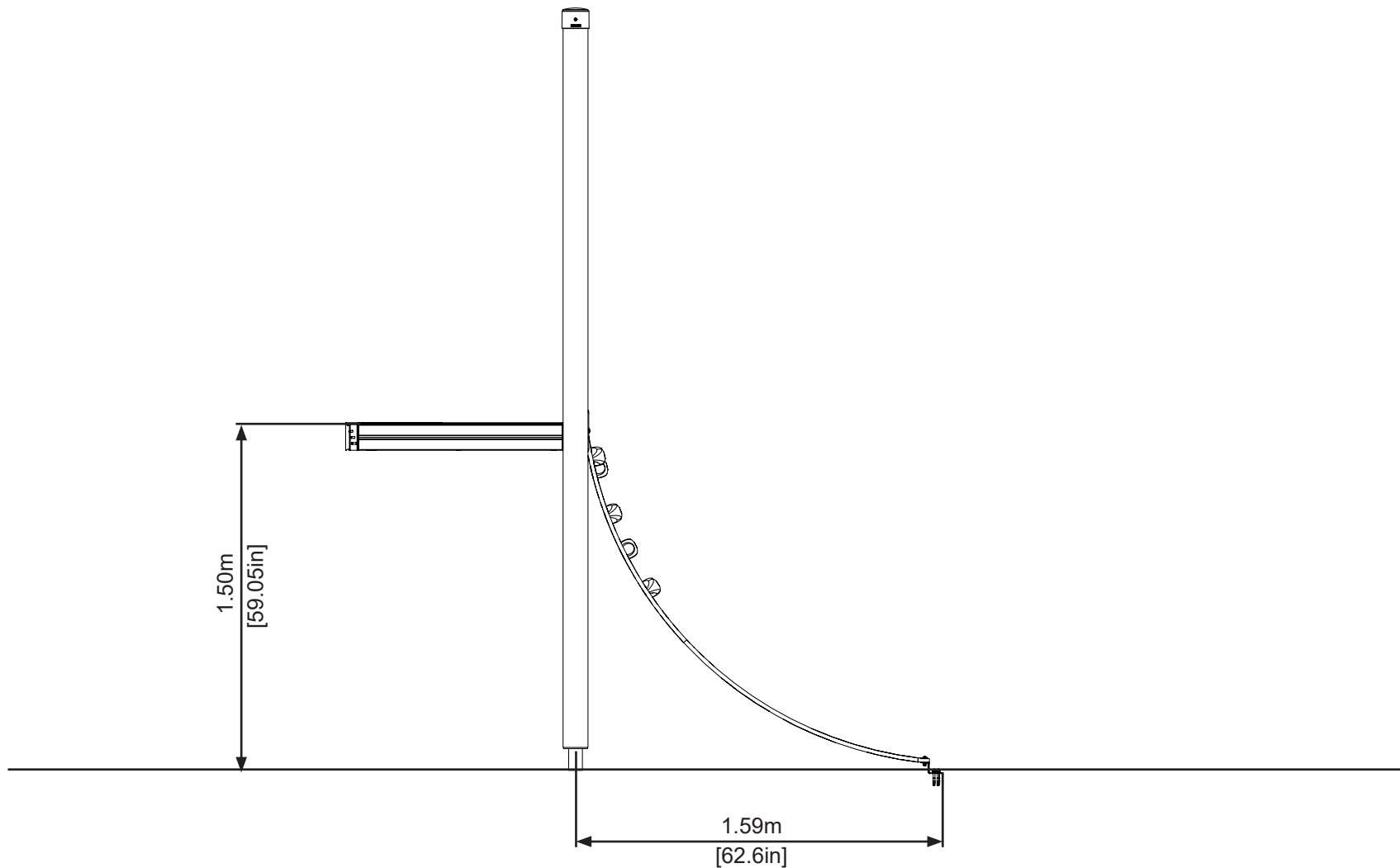

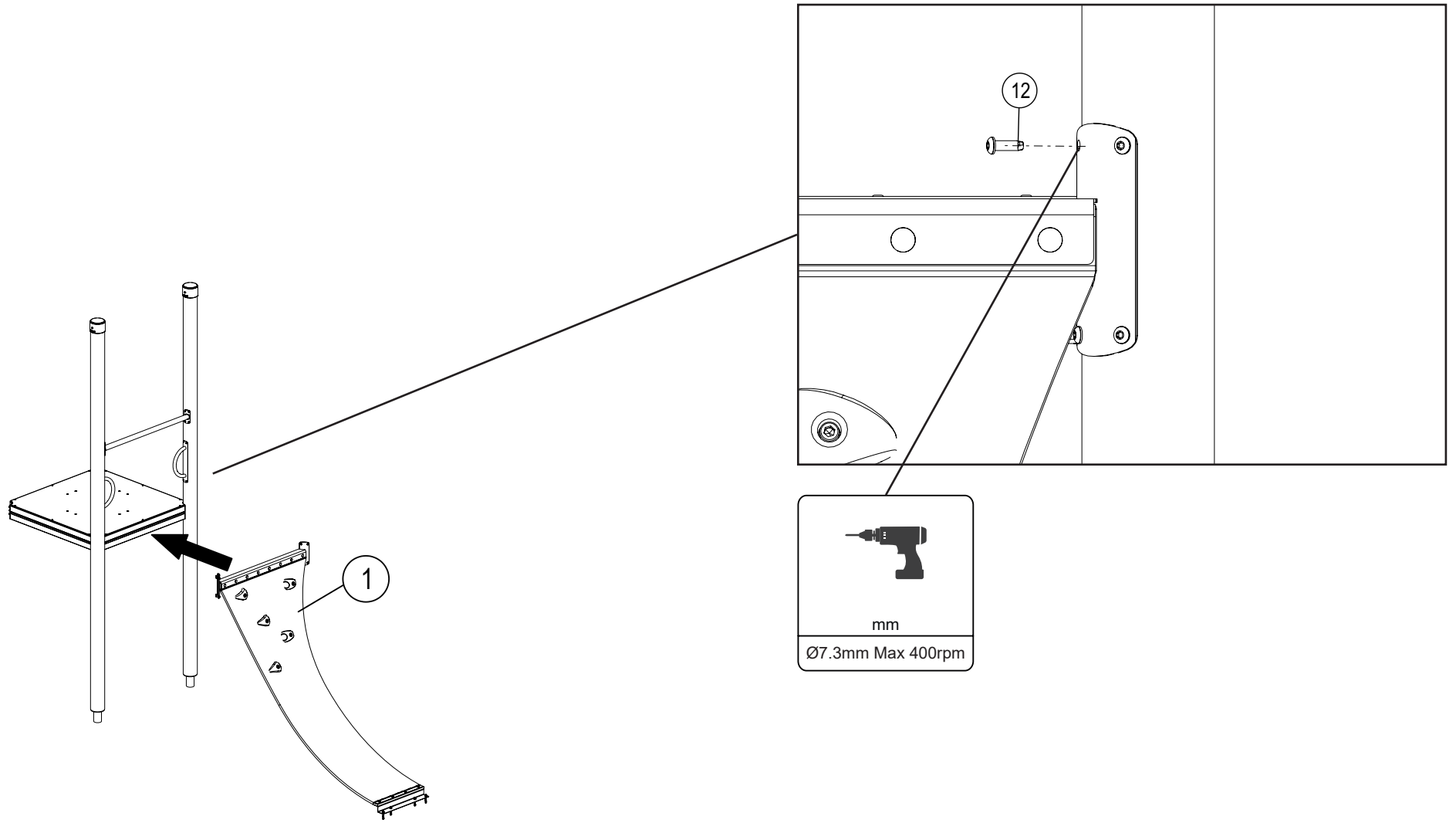

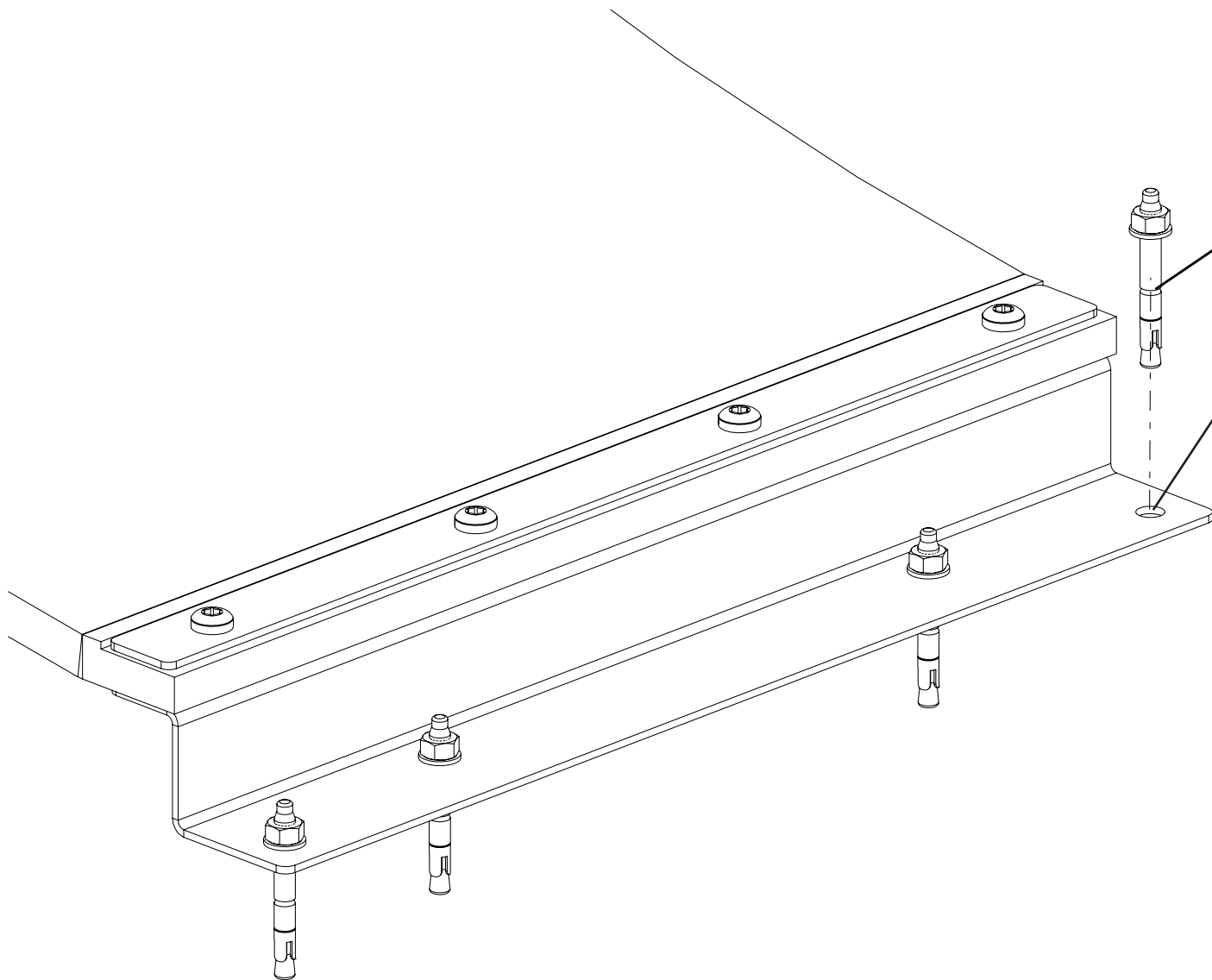

mm  
Ø10mm



Depth  
80mm

