

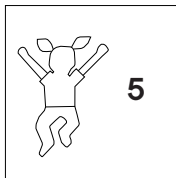

# CONE CLIMBER 1800

EN1176-1:2017  
EN1176-11:2014

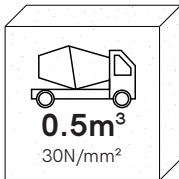
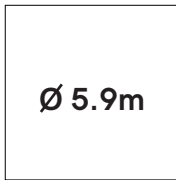
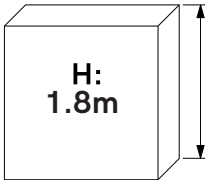
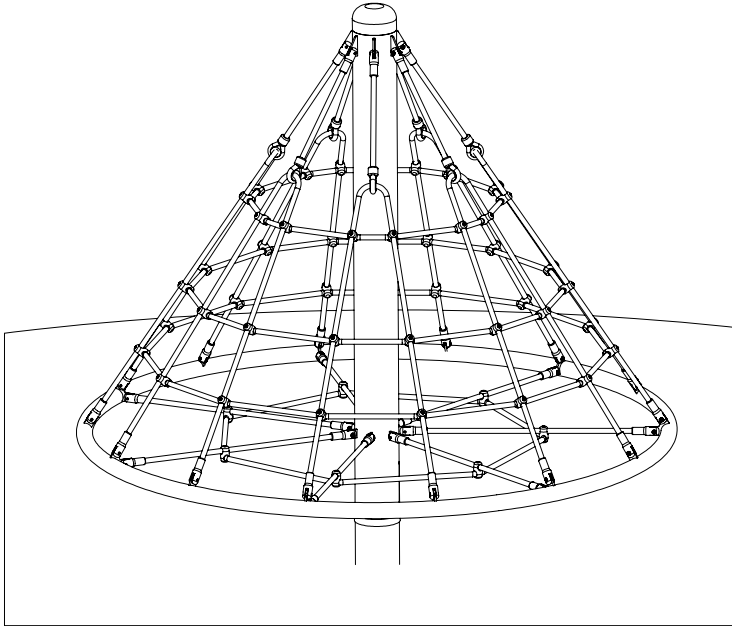

2-5	
6	
7	
8-14	
15	



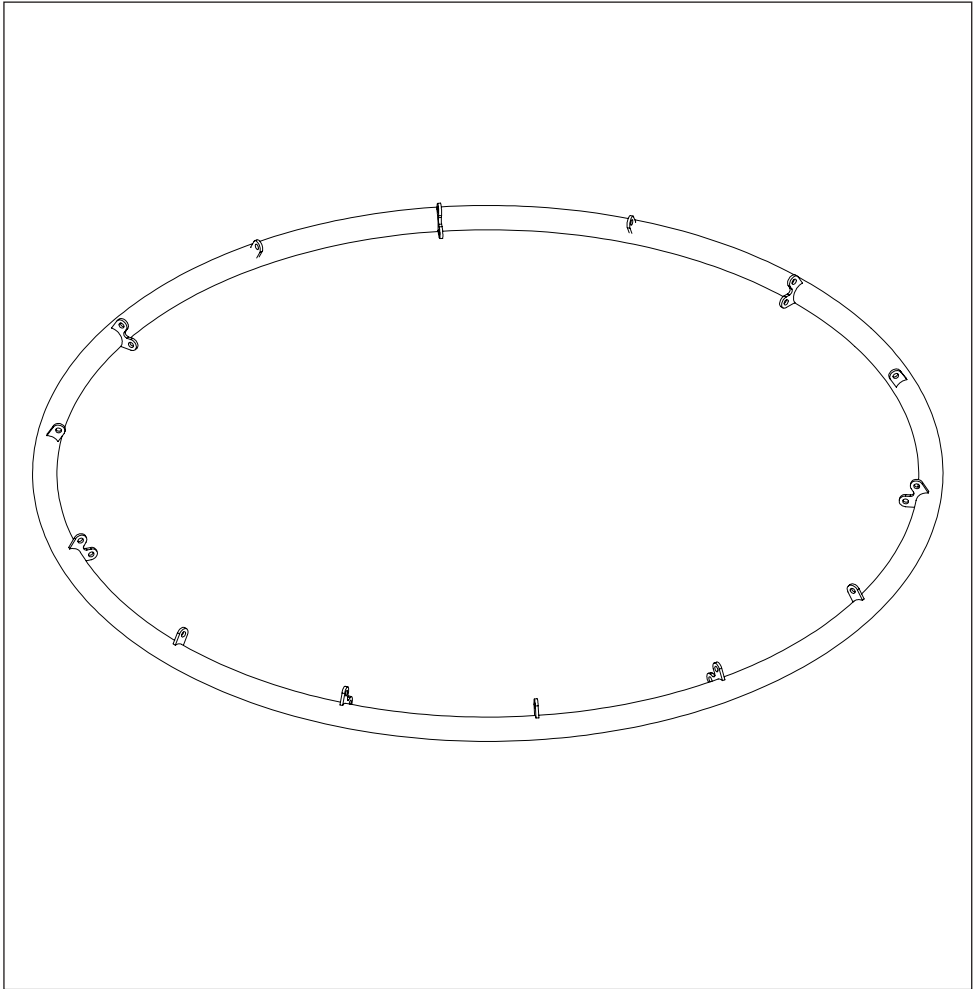

#



1.01



1

STAINLESS STEEL RING



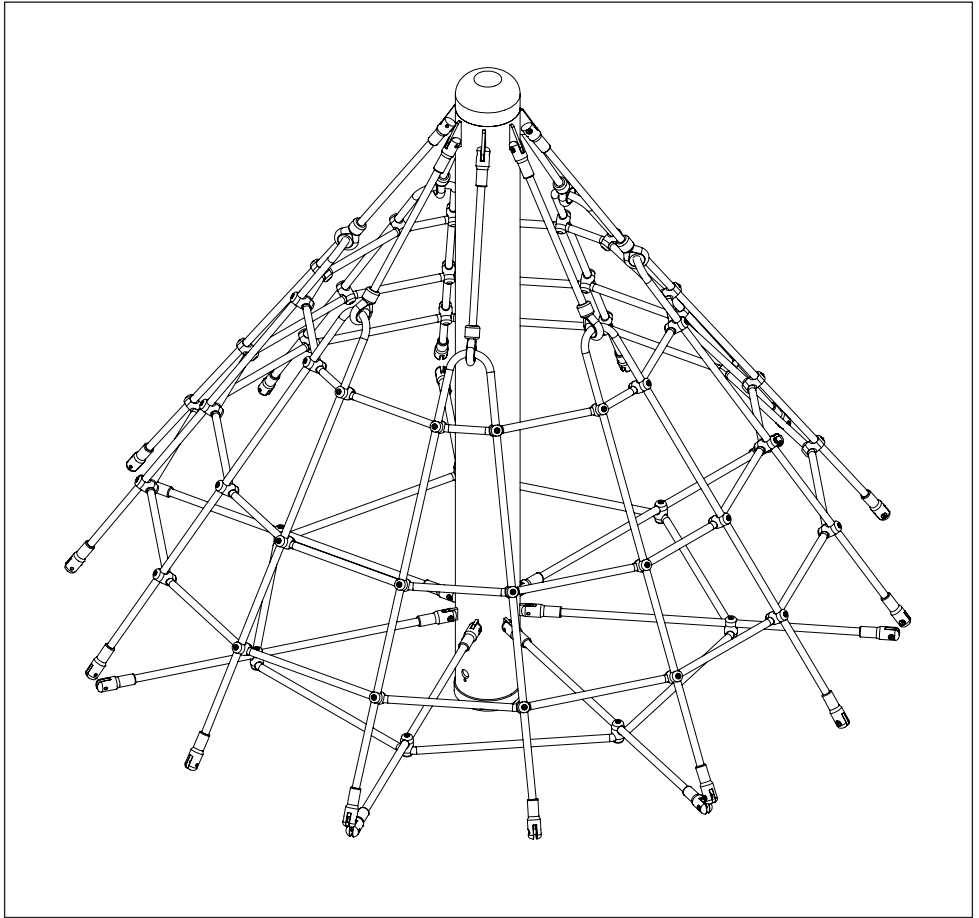

#



2.01



1

MAST / DOME

2.02





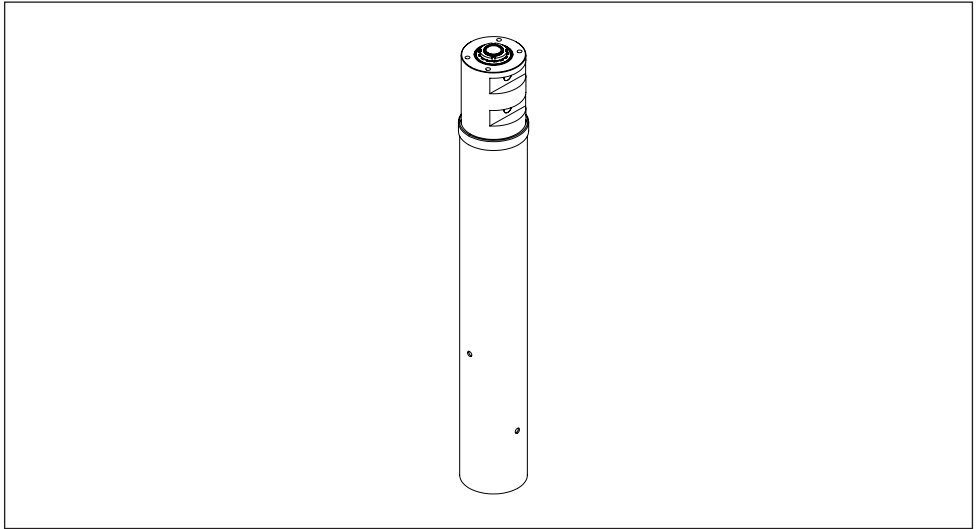

2

NET / CLEVIS FERRULES



















#			
3.01		1	STUMP
3.02		2	THREADED BAR
4.01		1	BEARING AXLE
4.02		1	LOCK NUT (BEARING)
4.03		1	LOCK WASHER (BEARING)
4.04		1	TAPERED SLEEVE (BEARING)
4.05		1	BEARING HOUSING





#			
5.01		1	TOP PLATE
5.02		1	RESTRICTOR
5.03		1	MOUNTING NECK
5.04		4	BOLT, M6x10 / WASHER
5.05		4	BOLT, M6x25 / WASHER / NUT
5.06		2	SPIDER COUPLING
5.07		2	SPIDER COUPLING KEY
4.06		1	RAINSHIELD
4.07		4	BOLT, M10x30 / WASHER
4.08		1	COVER PLATE / COVER GASKET
4.09		2	WEDGE
4.10		2	GRUB SCREW, M20x30
4.11		2	PLATE BOLT
2.03		27	BOLT, M6x25, COUNTERSUNK
2.04		27	CLEVIS SPACER



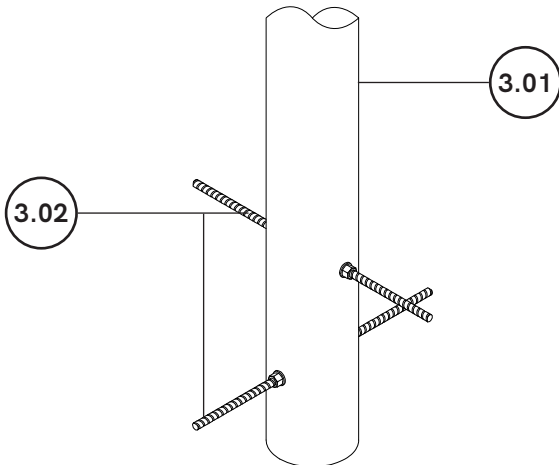
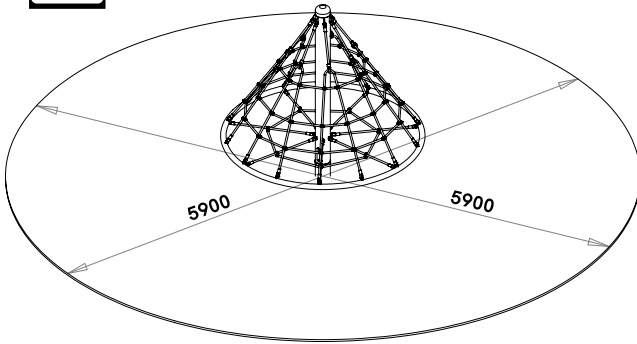
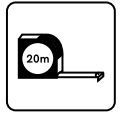

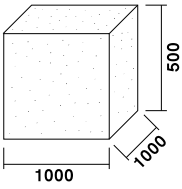
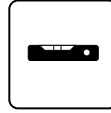
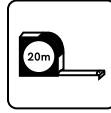

7 x 24h

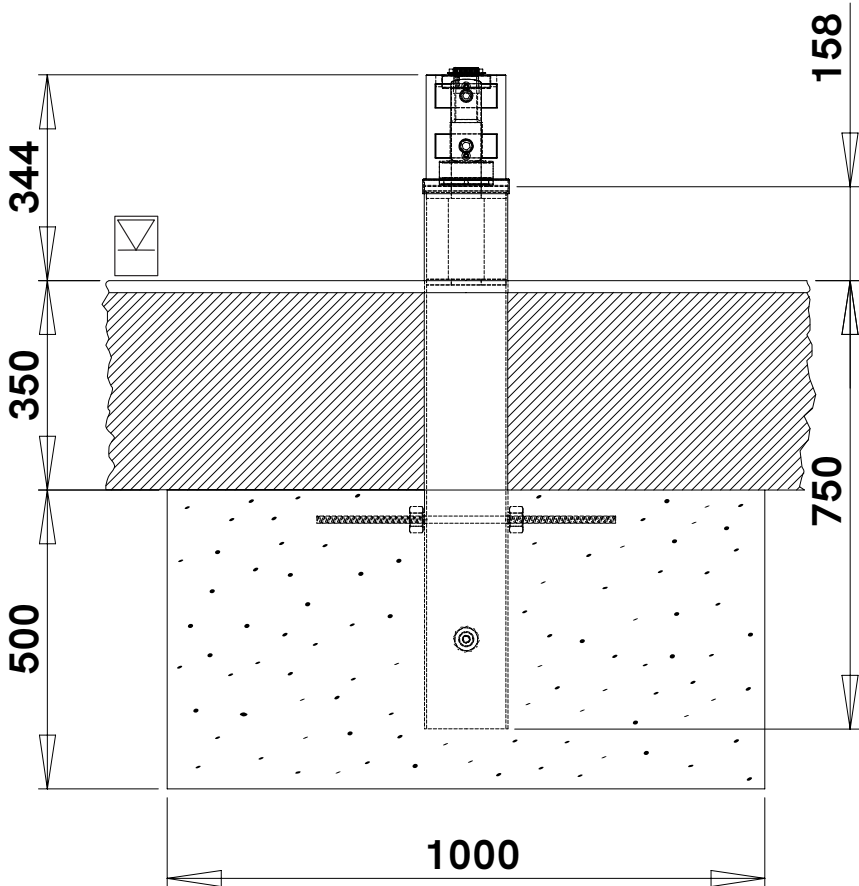

1

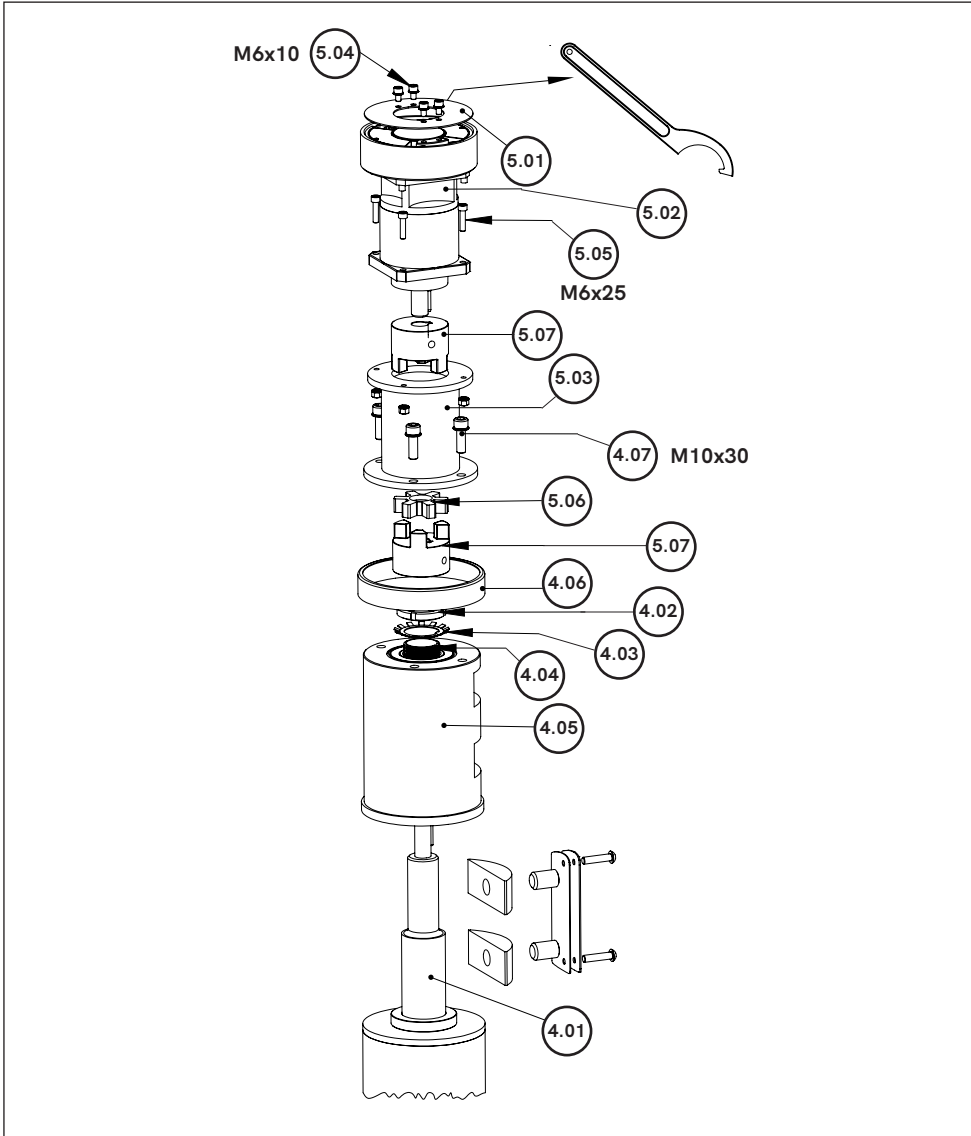
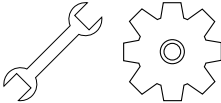



2.1

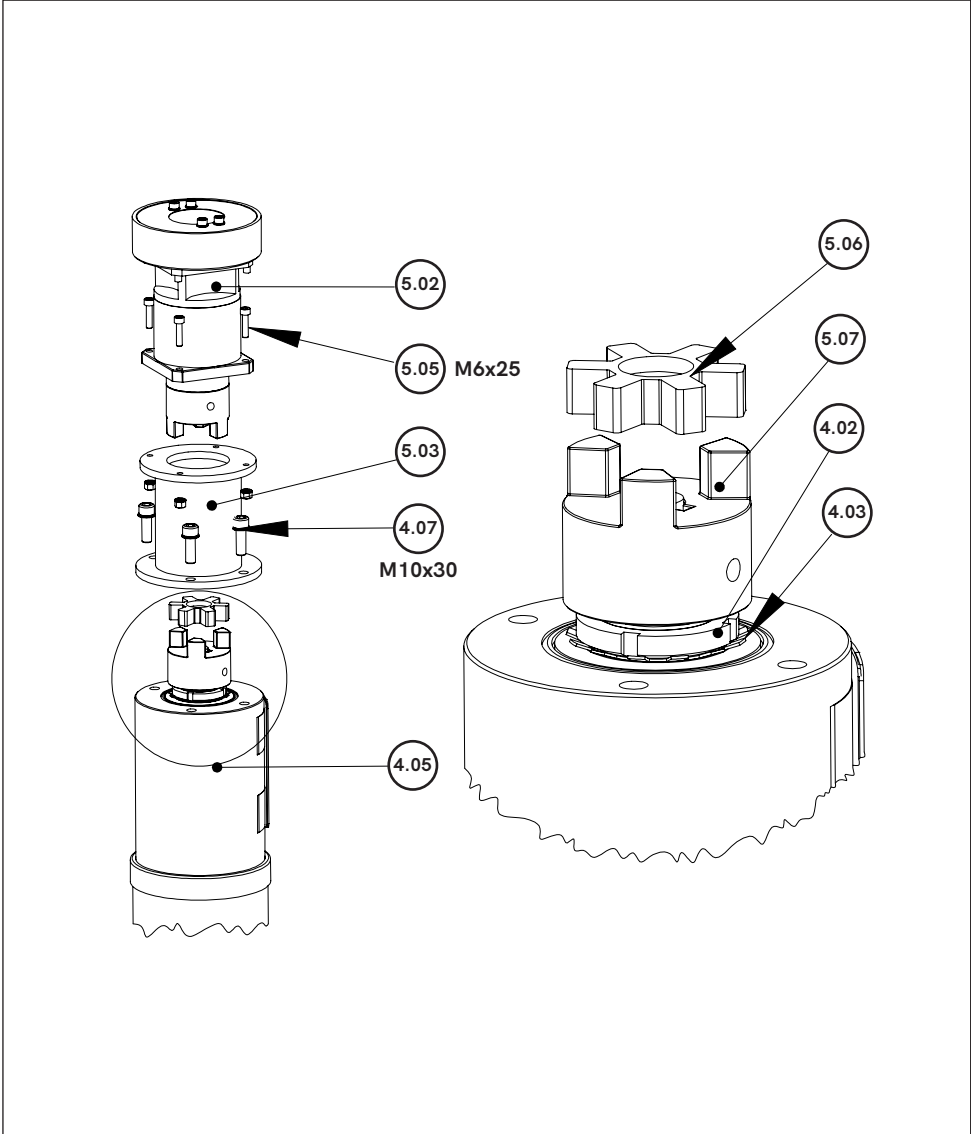
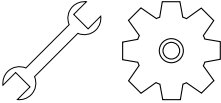

2.2

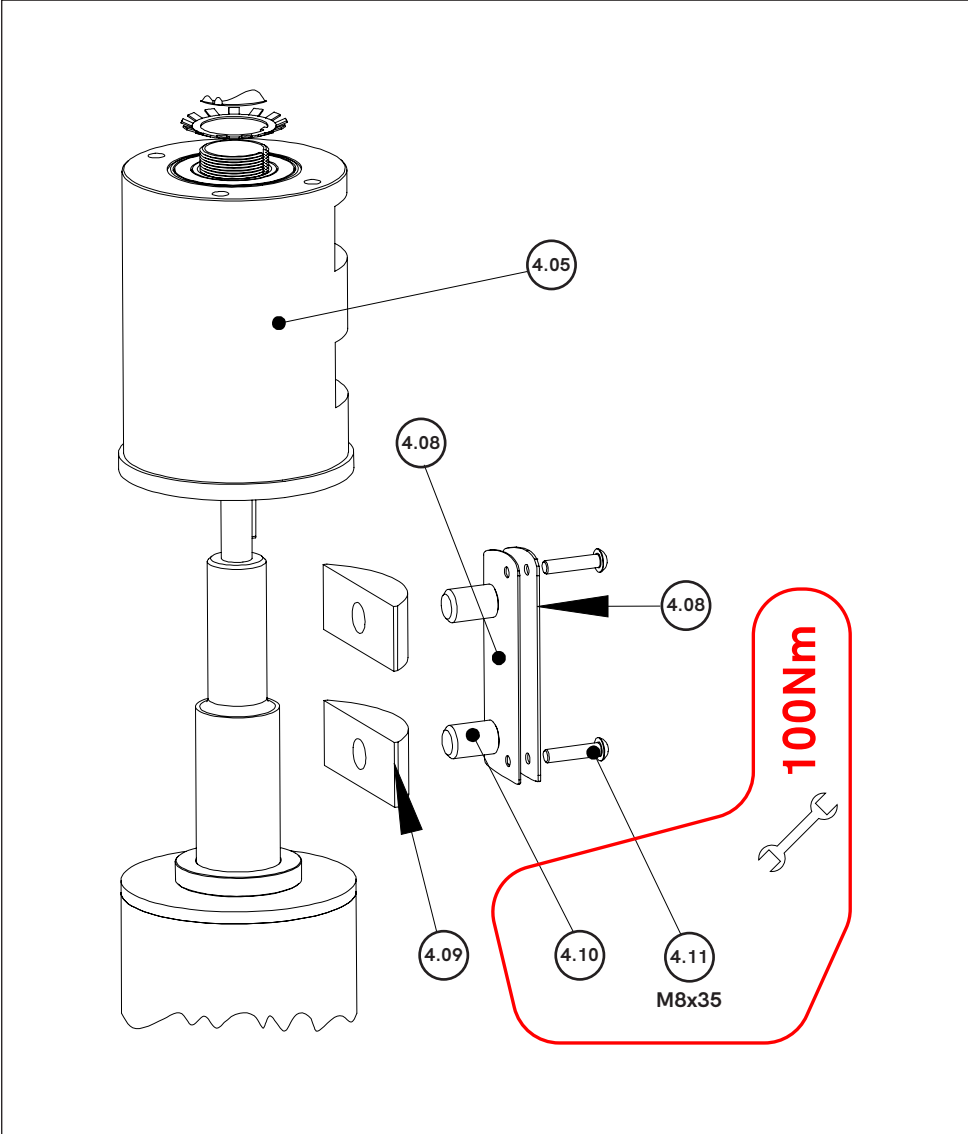
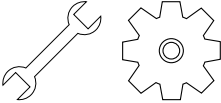

3

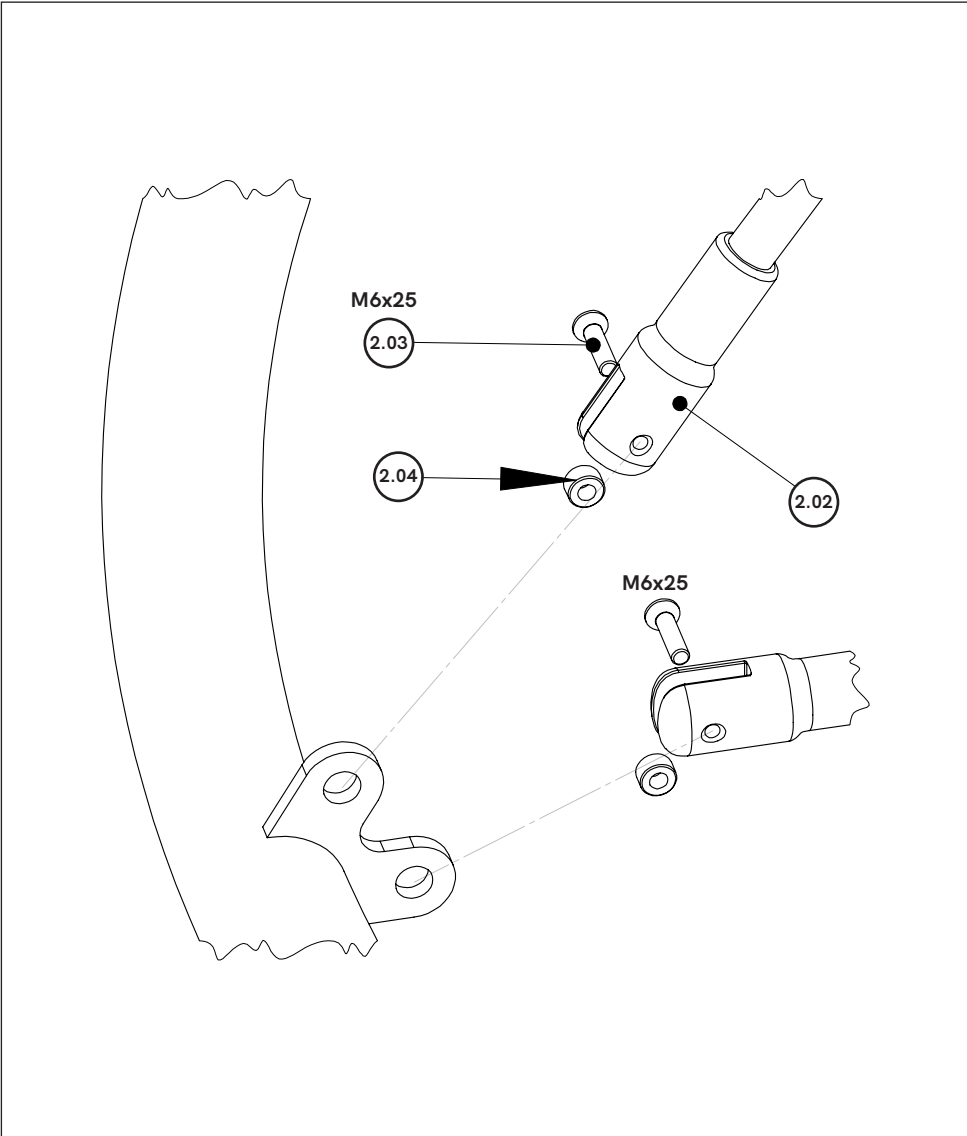
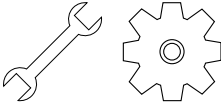

3

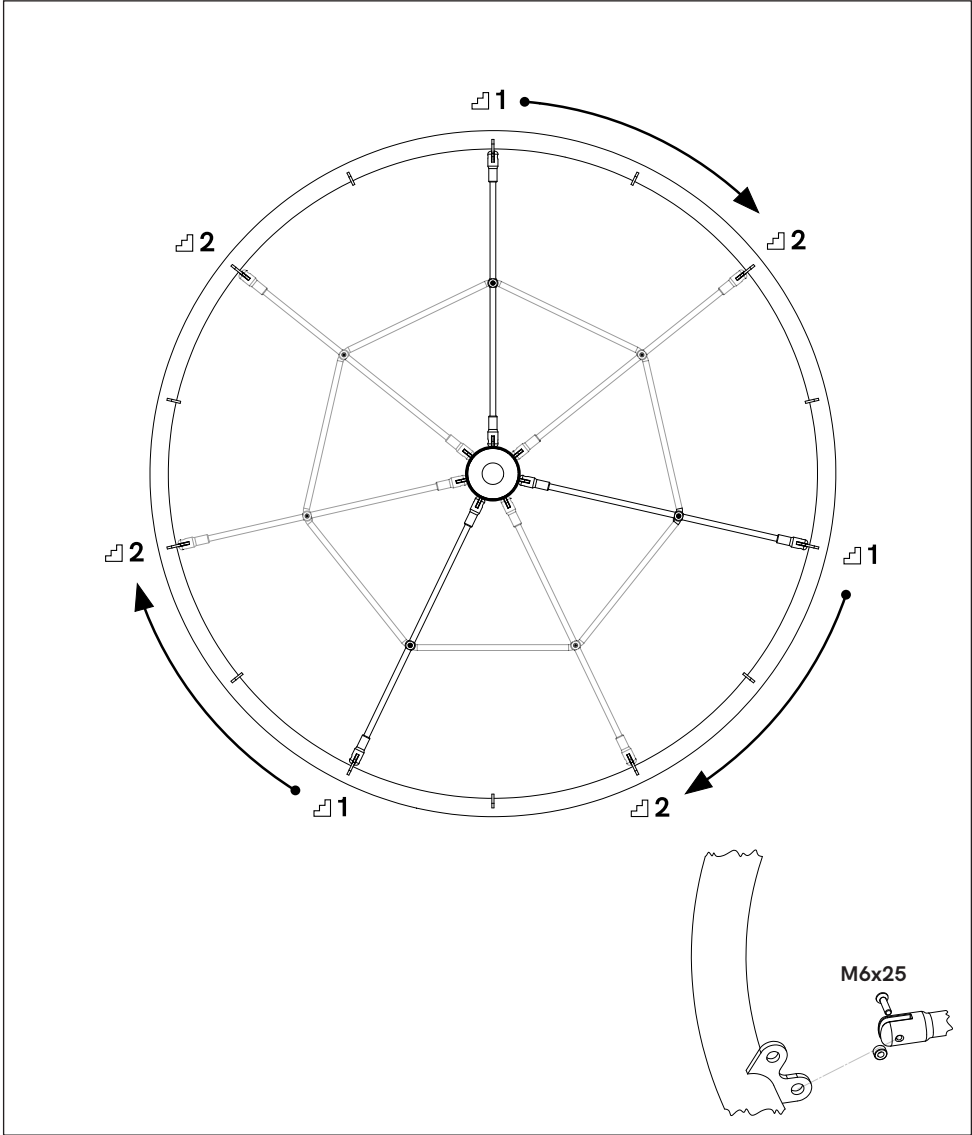
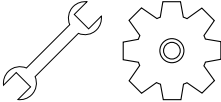

3

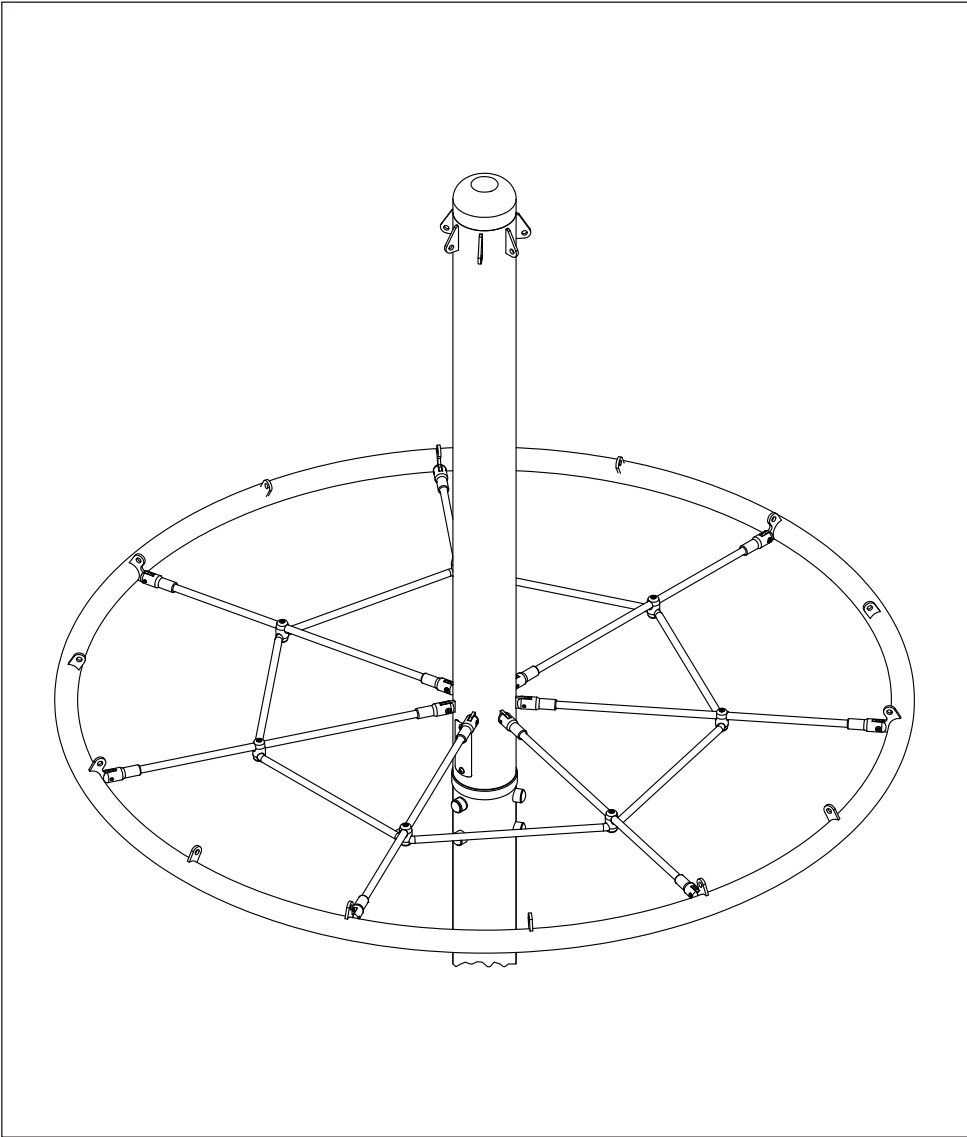
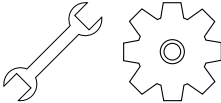

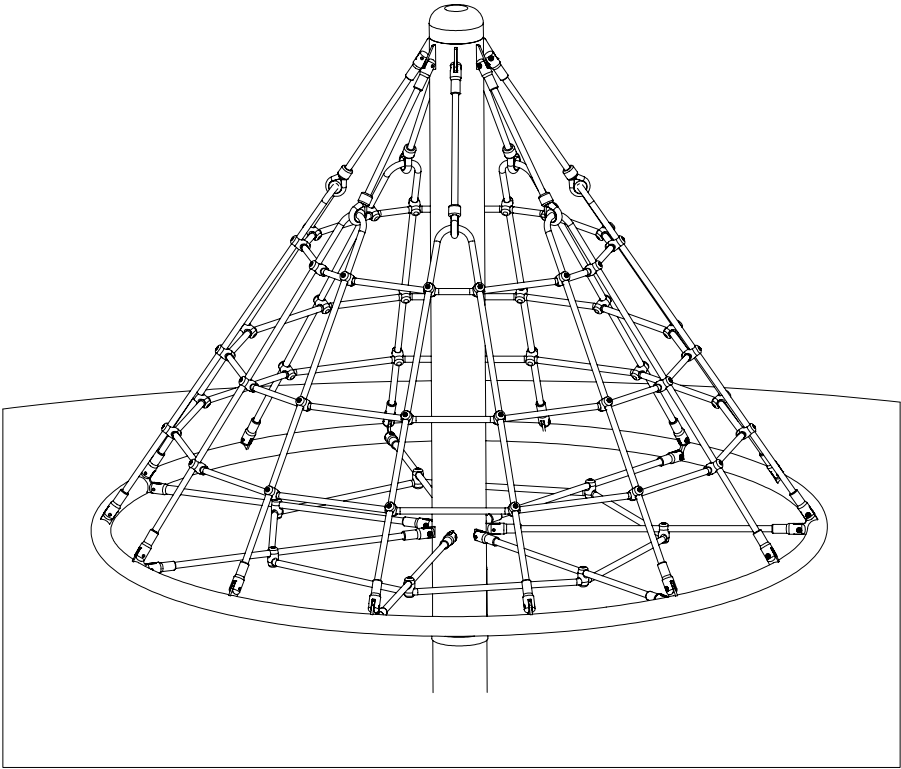



## Tayplay Ltd

13A Riverview Business Park  
Friarton Road  
Perth  
PH2 8DF  
Scotland

Tel: +44 (0) 1738 449 084  
Fax: +44 (0) 1738 449 094  
Email: [info@tayplay.com](mailto:info@tayplay.com)  
Web: [www.tayplay.com](http://www.tayplay.com)

